

Dephasure channel and superadditivity of coherent information

Felix Leditzky

(JILA & CTQM, University of Colorado Boulder)

joint work with Debbie Leung and Graeme Smith

[arXiv:1806.08327](https://arxiv.org/abs/1806.08327)

Beyond IID, Cambridge, UK

26 July 2018

Outline

- 1 Quantum capacity of a quantum channel
- 2 (Anti)degradable channels and quantum capacity bounds
- 3 Dephasure channel and its properties
- 4 Summary & Outlook

Table of Contents

- 1 Quantum capacity of a quantum channel
- 2 (Anti)degradable channels and quantum capacity bounds
- 3 Dephasure channel and its properties
- 4 Summary & Outlook

Entanglement generation

- ▶ Entanglement can be used as a resource in: teleportation, dense coding, entanglement-assisted communication, ...
- ▶ Assume Alice and Bob can communicate via a **noisy quantum channel** $\mathcal{N}: A \rightarrow B$.
- ▶ **Entanglement generation:** Use the noisy channel and local operations to generate entanglement between the parties.
- ▶ We can allow for **one-way classical communication** without changing the task.

Entanglement generation

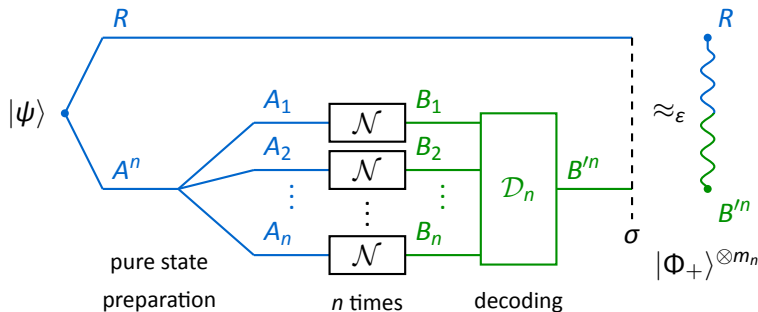

- ▶ **Goal:** Generate m_n ebits $|\Phi_+\rangle \sim |00\rangle + |11\rangle$ through n uses of the quantum channel \mathcal{N} .
- ▶ **Alice** prepares $|\psi\rangle_{RA^n}$ and sends A^n to **Bob** through $\mathcal{N}^{\otimes n}$.
- ▶ **Quantum capacity** $Q(\mathcal{N}) := \sup \left\{ \lim \frac{m_n}{n} \text{ s.t. } \epsilon \xrightarrow{n \rightarrow \infty} 0 \right\}$.

Quantum capacity

- ▶ **Coding theorem:** [Lloyd 1997; Shor 2002; Devetak 2005]

$$Q(\mathcal{N}) = \lim_{n \rightarrow \infty} \frac{1}{n} Q^{(1)}(\mathcal{N}^{\otimes n}) \quad (*)$$

where the **channel coherent information** $Q^{(1)}(\cdot)$ is defined as

$$Q^{(1)}(\mathcal{N}) := \max_{|\psi\rangle_{A'A}} I(A' \rangle B)_{(\text{id} \otimes \mathcal{N})(\psi)}.$$

with the coherent information $I(P \rangle Q)_\rho = S(Q)_\rho - S(PQ)_\rho$.

- ▶ **Regularized formula** (*) in general **intractable to compute**.
- ▶ Notorious example: Qubit depolarizing channel

$$\mathcal{D}_p(\rho) := (1 - p)\rho + \frac{p}{3}(X\rho X + Y\rho Y + Z\rho Z).$$

- ▶ **Known:** $Q(\mathcal{D}_0) = 1$ and $Q(\mathcal{D}_p) = 0$ for $p \geq 0.25$ (no-cloning).

Qubit depolarizing channel

- ▶ **Unknown:** $Q(\mathcal{D}_p)$ for $p \in (0, 1/4)$.

- ▶ Partial answer for *low noise* ($p \gtrsim 0$):

$$\mathcal{D}_p \approx \text{id} \implies Q(\mathcal{D}_p) \approx Q^{(1)}(\mathcal{D}_p) \quad \text{up to } O(p^2 \log p)$$

[FL, Leung, Smith 2017] based on [Sutter et al. 2017]

- ▶ **Superadditivity:** $Q^{(1)}(\mathcal{D}_p) = 0$ for $p \geq 0.1894$, but

$$Q^{(1)}(\mathcal{D}_p^{\otimes 3}) > 0 \text{ for } p \lesssim 0.1901. \quad [\text{DiVincenzo et al. 1998}]$$

- ▶ Achieved by repetition code $\sim |0\rangle^{\otimes n} + |1\rangle^{\otimes n}$ (**degenerate** code).

- ▶ Result: there are \mathcal{N} and $n \in \mathbb{N}$ s.t. $Q^{(1)}(\mathcal{N}^{\otimes n}) > nQ^{(1)}(\mathcal{N})$.

- ▶ For which channels is superadditivity *not possible*, i.e.,

$$Q^{(1)}(\mathcal{N}^{\otimes n}) \leq nQ^{(1)}(\mathcal{N})?$$

Table of Contents

- 1 Quantum capacity of a quantum channel
- 2 (Anti)degradable channels and quantum capacity bounds
- 3 Dephasure channel and its properties
- 4 Summary & Outlook

Degradable and antidegradable channels

- ▶ **Complementary channel $\mathcal{N}^c: A \rightarrow E$** associated to \mathcal{N} models the **leakage of information** to the environment.
- ▶ Degradable channels have additive channel coherent information, $Q^{(1)}(\mathcal{N}^{\otimes n}) = nQ^{(1)}(\mathcal{N})$. [Devetak and Shor 2005]
- ▶ **Single-letter quantum capacity:** $Q(\mathcal{N}) = Q^{(1)}(\mathcal{N})$.

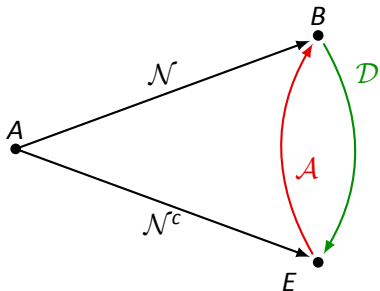

degradable:

$\exists \mathcal{D}: B \rightarrow E$ s.t.

$$\mathcal{N}^c = \mathcal{D} \circ \mathcal{N}$$

antidegradable:

$\exists \mathcal{A}: E \rightarrow B$ s.t.

$$\mathcal{N} = \mathcal{A} \circ \mathcal{N}^c$$

Degradable and antidegradable channels

- ▶ Antidegradable channels: $Q(\mathcal{N}) = 0$ due to **no-cloning**.
- ▶ Data-processing: $Q^{(1)}(\mathcal{N}) \leq 0$ for antidegradable channels.
- ▶ \mathcal{D}_p is antidegradable for $p \geq 1/4$.

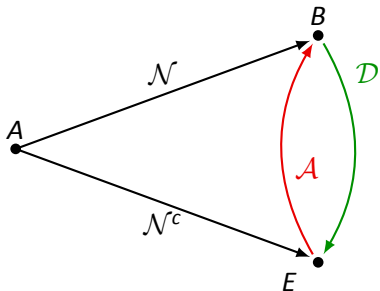

degradable:

$\exists \mathcal{D}: B \rightarrow E$ s.t.

$$\mathcal{N}^c = \mathcal{D} \circ \mathcal{N}$$

antidegradable:

$\exists \mathcal{A}: E \rightarrow B$ s.t.

$$\mathcal{N} = \mathcal{A} \circ \mathcal{N}^c$$

Methods of bounding the quantum capacity

- ▶ Given a quantum channel that is *not* degradable/antidegradable, how can we bound its quantum capacity?
- ▶ If channel is almost degradable, then capacity $Q(\cdot)$ should be close to $Q^{(1)}(\cdot)$ → **approximate degradability** [Sutter et al. 2017]
- ▶ Give additional resources (NS/PPT-assistance) to the communicating parties that make quantities more "well-behaved". → **SDP bounds**
[Leung and Matthews 2015; Wang et al. 2017]
- ▶ Decompose the channel into degradable/antidegradable parts and use their nice properties.
→ [Smith and Smolin 2008] [FL, Datta, Smith 2017]

Decomposition method

- ▶ Main insight: $Q(\cdot)$ is **convex** on channels with **additive** $Q^{(1)}(\cdot)$.
[Wolf and Pérez-García 2007]
- ▶ This is true even if the channels in a decomposition are only completely positive, but not necessarily trace-preserving.

Upper bound on $Q(\cdot)$

[FL, Datta, Smith 2018; Yang (in prep.)]

Let $\mathcal{N} = \sum_i p_i \mathcal{E}_i + \sum_i q_i \mathcal{F}_i$, where the \mathcal{E}_i are **degradable** CP maps and the \mathcal{F}_i are **antidegradable**. Then,

$$Q(\mathcal{N}) \leq \sum_i p_i Q^{(1)}(\mathcal{E}_i).$$

- ▶ This yields strongest upper bound on $Q(\mathcal{D}_p)$ in high-noise regime (presented at BIID '17).

Optimality of our bound

Main principle

For a channel $\mathcal{N} = (1 - \lambda)\mathcal{E} + \lambda\mathcal{F}$, with \mathcal{E} degradable and \mathcal{F} antidegradable, we only count **degradable contributions**:

$$Q(\mathcal{N}) \leq (1 - \lambda)Q^{(1)}(\mathcal{E}) = (1 - \lambda)Q^{(1)}(\mathcal{E}) + \underbrace{\lambda Q^{(1)}(\mathcal{F})}_{=0}$$

- ▶ Is there hope to improve our bound by also counting (negative) antidegradable contributions from a joint optimization?

$$\begin{aligned} (1 - \lambda) \max_{\varphi} I(A \rangle B)_{\mathcal{E}(\varphi)} + \lambda \max_{\varphi} I(A \rangle B)_{\mathcal{F}(\varphi)} &\geq Q(\mathcal{N}) \\ &\geq \checkmark \qquad \qquad \qquad \geq ? \\ \text{convexity} &\max_{\varphi} \left\{ (1 - \lambda)I(A \rangle B)_{\mathcal{E}(\varphi)} + \underbrace{\lambda I(A \rangle B)_{\mathcal{F}(\varphi)}}_{\leq 0} \right\} \\ \text{of } \max(\cdot) & \end{aligned}$$

Optimality of our bound

- ▶ Simple case: **flagged channel** (\mathcal{E} deg., \mathcal{F} antideg.)

$$\mathcal{N}_f = (1 - \lambda)\mathcal{E} \otimes |0\rangle\langle 0| + \lambda\mathcal{F} \otimes |1\rangle\langle 1| \quad (*)$$

- ▶ Bob can decide which channel occurred by first measuring flag.
- ▶ Easy to show:

$$Q^{(1)}(\mathcal{N}_f) = \max_{\varphi} \{ (1 - \lambda)I(A \rangle B)_{\mathcal{E}(\varphi)} + \lambda I(A \rangle B)_{\mathcal{F}(\varphi)} \}$$

- ▶ This is the conjectured upper bound on $Q(\cdot)$!
- ▶ Hence, **if true**, any channel \mathcal{N}_f of the form $(*)$ must have **additive coherent information**, since

$$Q^{(1)}(\mathcal{N}_f) \leq Q(\mathcal{N}_f) \leq \text{conj. upper bound} = Q^{(1)}(\mathcal{N}_f).$$

- ▶ **Counterexample!** \longrightarrow Dephasure channel

Table of Contents

- 1 Quantum capacity of a quantum channel
- 2 (Anti)degradable channels and quantum capacity bounds
- 3 Dephasure channel and its properties**
- 4 Summary & Outlook

Introducing: the dephasure channel

Dephasure channel

(dephasing + erasure)

For $p, q \in [0, 1]$,

$$\mathcal{N}_{p,q}(\rho) := (1 - q)((1 - p)\rho + pZ\rho Z) + q \text{Tr}(\rho)|e\rangle\langle e|.$$

- ▶ Dephasure channel is of the form

$$(1 - q) \text{deg.} + q \text{antideg.}$$

- ▶ **Flagged channel**, since $\langle e|\rho|e\rangle = 0$ for all ρ .
- ▶ Restrict to $p, q \in [0, 1/2]$ from now on.
- ▶ $\mathcal{N}_{p,q}$ is **simple but weird**: exhibits superadditivity of coherent information already for two uses of the channel.

Antidegradability of the dephasure channel

- ▶ **Dephasure channel:**

$$\mathcal{N}_{p,q}(\rho) = (1 - q)((1 - p)\rho + pZ\rho Z) + q \text{Tr}(\rho)|e\rangle\langle e|$$

- ▶ **Complementary channel:**

$$\mathcal{N}_{p,q}^c(\rho) = q\rho \oplus (1 - q) \sum_{x=0,1} \langle x|\rho|x\rangle |\varphi_p^x\rangle\langle\varphi_p^x|,$$

where $|\varphi_p^x\rangle = \sqrt{1-p}|0\rangle + (-1)^x\sqrt{p}|1\rangle$.

- ▶ Complementary channel is also flagged!
- ▶ Want to construct antidegrading map \mathcal{A} such that

$$\mathcal{N}_{p,q} = \mathcal{A} \circ \mathcal{N}_{p,q}^c.$$

- ▶ **Idea:** unambiguous state discrimination for φ_p^x .

Antidegradability of the dephrasing channel

Unambiguous state discrimination (USD):

- ▶ Input: two non-orthogonal states $|\psi_1\rangle, |\psi_2\rangle$ with $\langle\psi_1|\psi_2\rangle \neq 0$.
- ▶ Design POVM $\{\Pi_1, \Pi_2, \Pi_?\}$ such that
 $\langle\psi_1|\Pi_2|\psi_1\rangle = \langle\psi_2|\Pi_1|\psi_2\rangle = 0$.
- ▶ Hence, when receiving outcome "1" or "2" we are certain that we have ψ_1 or ψ_2 .
- ▶ Have to abort if we get outcome "?".
- ▶ **Optimal measurement:** $\min \Pr(?) = |\langle\psi_1|\psi_2\rangle|$

[Ivanovic 1987; Dieks 1988; Peres 1988]

Antidegradability of the dephrasing channel

Strategy:

$$\mathcal{N}_{p,q}^c(\rho) = q\rho \otimes |0\rangle\langle 0|_F + (1-q) \sum_{x=0,1} \langle x|\rho|x\rangle |\varphi_p^x\rangle\langle \varphi_p^x| \otimes |1\rangle\langle 1|_F$$

measure flag F

outcome $|0\rangle\langle 0|$:

post-process ρ

(erase with prob. $1 - \frac{(1-q)(1-2p)}{q}$)

outcome $|1\rangle\langle 1|$:

USD to recover $\langle x|\rho|x\rangle$

(erase on "?")

- ▶ Resulting map successfully degrades $\mathcal{N}_{p,q}^c$ to

$$\mathcal{N}_{p,q}(\rho) = (1-q)((1-p)\rho + pZ\rho Z) + q \text{Tr}(\rho)|e\rangle\langle e|.$$

- ▶ Map is completely positive iff $q \geq (1-q)(1-2p)$.

Antidegradability of the dephasure channel

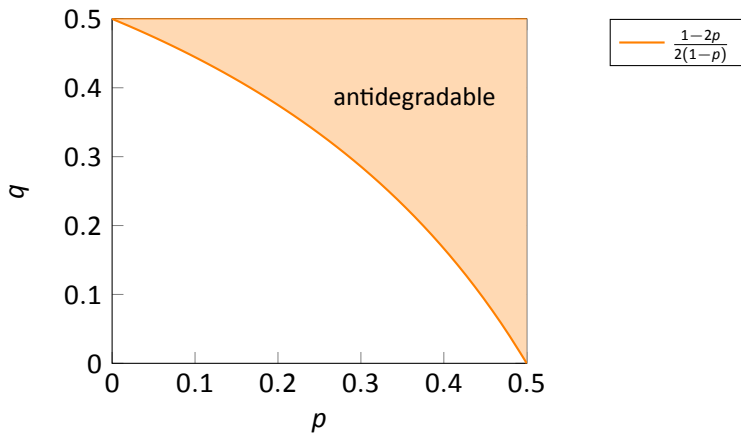

Single-letter coherent information

- ▶ For superadditivity of coherent information:
need to know $Q^{(1)}(\mathcal{N}_{p,q})$.

- ▶ Erasure flag: easy to show that

$$Q^{(1)}(\mathcal{N}_{p,q}) = \max_{|\varphi\rangle_{AA'}} \{ (1-q)I(A)B)_{\mathcal{Z}_p(\varphi)} - qS(A)_\varphi \},$$

where $\mathcal{Z}_p(\rho)$ is the dephasing channel.

- ▶ Form of $Q^{(1)}(\mathcal{N}_{p,q})$ suggests that optimal state is diagonal in Z-basis \rightarrow true! (simple calculus)

- ▶
$$Q^{(1)}(\mathcal{N}_{p,q}) = \max_z \left\{ (1-2q) S \left(\begin{pmatrix} (1+z)/2 & 0 \\ 0 & (1-z)/2 \end{pmatrix} \right) - (1-q) S \left(\begin{pmatrix} 1-p & z\sqrt{p(1-p)} \\ z\sqrt{p(1-p)} & p \end{pmatrix} \right) \right\}$$

Single-letter coherent information

$$\blacktriangleright Q^{(1)}(\mathcal{N}_{p,q}) = \max_{|\varphi\rangle_{AA'}} \{(1-q)I(A>B)_{\mathcal{Z}_p(\varphi)} - qS(\varphi_A)\}.$$

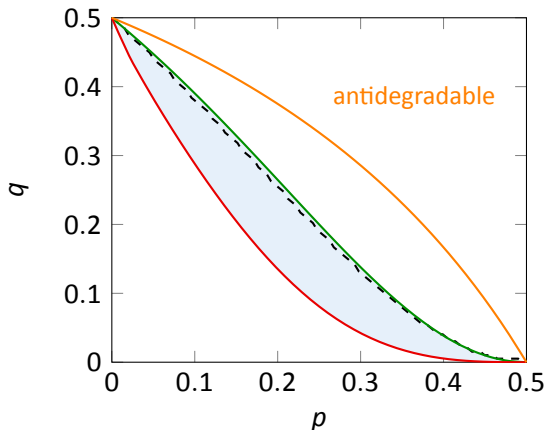

$$- - - Q^{(1)}(\mathcal{N}_{p,q}) = 0$$

inside green line:
optimizing state φ_A
diagonal in Z -basis

red region:
completely mixed state
maximizes $Q^{(1)}(\mathcal{N}_{p,q})$

within blue region:
examples of
superadditivity!

Superadditivity of coherent information

- ▶ First thing to try... **weighted repetition code:**

$$|\varphi_n\rangle = \sqrt{\lambda} |0\rangle_R |0\rangle_A^{\otimes n} + \sqrt{1-\lambda} |1\rangle_R |1\rangle_A^{\otimes n}$$

- ▶ For $n = 1$, this is the optimal single-letter code.
- ▶ $\mathcal{N}_{p,q}^{\otimes n} = ((1-q)\mathcal{Z}_p + q \text{Tr}(\cdot)|e\rangle\langle e|)^{\otimes n}$:
sum of channels of the form $\mathcal{Z}_p^{\otimes k} \otimes (\text{Tr}(\cdot)|e\rangle\langle e|)^{\otimes n-k}$.
- ▶ Coherent information splits up into different erasure patterns, since $S(\sum_i p_i \rho_i \otimes |i\rangle\langle i|) = \sum_i p_i S(\rho_i) + H(\{p_i\})$.
- ▶ Repetition code: all partial erasures cancel.
- ▶ Easy: compute action of dephasing $\mathcal{Z}_p^{\otimes n}$ on repetition code.

Superadditivity of coherent information

- ▶ (Almost) closed formula for repetition code ($\varphi_n = \varphi_n(\lambda)$):

$$Q^{(1)}(\varphi_n, \mathcal{N}_{p,q}^{\otimes n}) = ((1-q)^n - q^n) h(\lambda) - (1-q)^n \left(1 - u \operatorname{artanh} u - \frac{1}{2} \log(1-u^2) \right).$$

- ▶ $u = u(\lambda, p, n) = \sqrt{1 - 4\lambda(1-\lambda)(1 - (1-2p)^{2n})}$.
- ▶ $h(\lambda) = -\lambda \log \lambda - (1-\lambda) \log(1-\lambda)$ is the binary entropy of λ .
- ▶ To get superadditivity, maximize over parameter λ (weight of logical $|0\rangle$ in the repetition code).

Superadditivity of coherent information

- ▶ Weighted repetition code $|\varphi_n\rangle := \sqrt{\lambda}|0\rangle^{\otimes n+1} + \sqrt{1-\lambda}|1\rangle^{\otimes n+1}$.
- ▶ Plot for $n = 2, 3$ of the non-negative part of

$$\frac{1}{n} \max_{\lambda} I(A>B^n)_{\mathcal{N}_{p,q}^{\otimes n}(\varphi_n)} - Q^{(1)}(\mathcal{N}_{p,q})$$

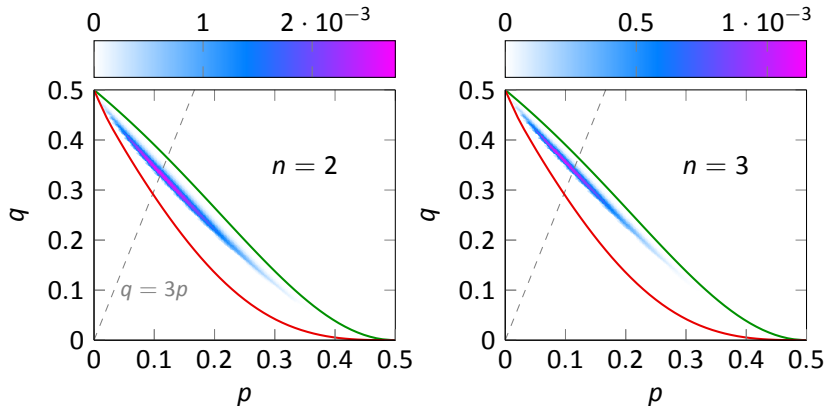

Superadditivity of coherent information

- ▶ Weighted repetition code $|\varphi_n\rangle := \sqrt{\lambda}|0\rangle^{\otimes n+1} + \sqrt{1-\lambda}|1\rangle^{\otimes n+1}$.
- ▶ Plot for $n = 4, 5$ of the non-negative part of

$$\frac{1}{n} \max_{\lambda} I(A>B^n)_{\mathcal{N}_{p,q}^{\otimes n}(\varphi_n)} - Q^{(1)}(\mathcal{N}_{p,q})$$

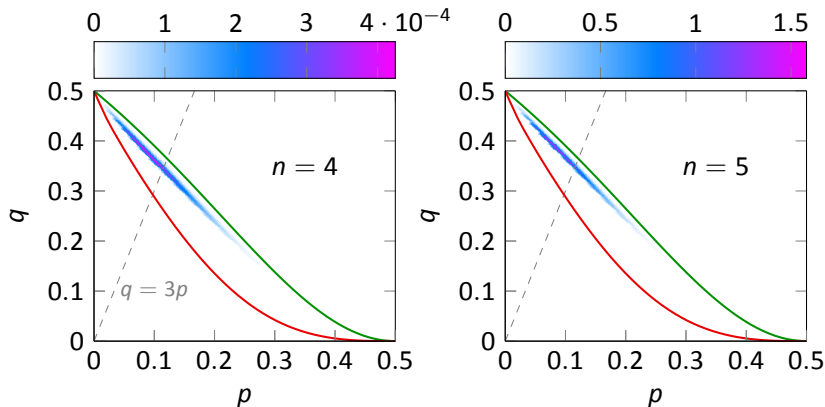

Superadditivity of coherent information

- ▶ Superadditivity also holds in the "extreme form":

$$Q^{(1)}(\mathcal{N}_{p,q}) = 0 \quad \text{but} \quad Q^{(1)}(\varphi_n, \mathcal{N}_{p,q}^{\otimes n}) > 0$$

for $n \geq 2$ and some $p, q \rightarrow$ **increased threshold**.

- ▶ We also have more elaborate codes achieving superadditivity, for example for $n = 3$:

$$\begin{aligned} |\chi_3\rangle := & |00\rangle|00\rangle \otimes |\psi_1\rangle + |11\rangle|11\rangle \otimes |\psi_1\rangle \\ & + |01\rangle|01\rangle \otimes |\psi_2\rangle + |10\rangle|10\rangle \otimes X|\psi_2\rangle, \end{aligned}$$

for some pure states $|\psi_i\rangle$.

- ▶ We also found good codes using a **neural network state ansatz**.

[Bausch, FL; arXiv:1806.08781]

- ▶ Not clear whether optimal codes for $n \geq 2$ are diagonal in Z-basis (true for $n = 1$)!

Superadditivity of coherent information

- ▶ Plot for $\mathcal{N}_{p,3p}$ along diagonal $(p, 3p)$
- ▶ Threshold is increased by repetition codes φ_n .

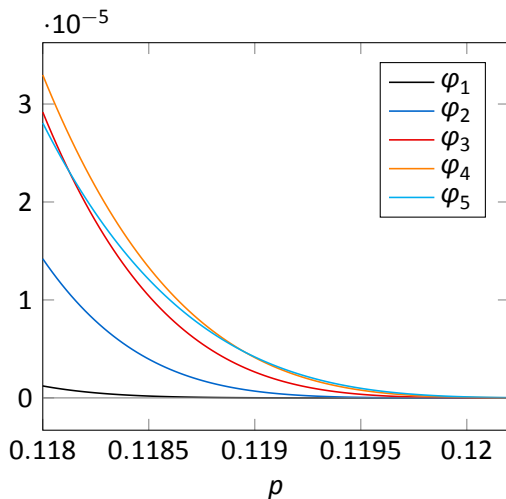

Numerical optimization techniques

- ▶ Easy observation: $I(A\setminus B)_{\psi \otimes \mathcal{N}(\varphi)} = 0$ for a product input state $|\psi\rangle_A \otimes |\varphi\rangle_{A'}$.
- ▶ Hence, **many local maxima** in high-noise regime where most states have negative channel coherent information.
- ▶ Gradient is likely to get stuck \longrightarrow gradient-free optimization?
- ▶ Many biology-inspired examples: genetic algorithms, artificial bee colonization, **particle swarm optimization (PSO)**
- ▶ Idea of PSO:
 - ▷ Send out N particles, each probing the landscape.
 - ▷ Each particle records personal best function value, and all know the global swarm best.
 - ▷ In each iteration, particle velocity is updated with weights towards personal best, global best, and inertial movement.

Particle swarm optimization

Ackley function: $f(x, y) =$

$$-20 \exp \left[-0.2 \sqrt{0.5(x^2 + y^2)} \right] - \exp [0.5(\cos 2\pi x + \cos 2\pi y)] + e + 20$$

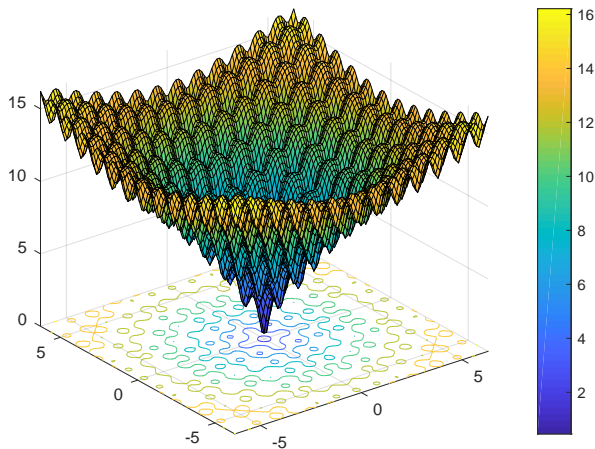

Particle swarm optimization

Ackley function: $f(x, y) =$

$$-20 \exp \left[-0.2 \sqrt{0.5(x^2 + y^2)} \right] - \exp [0.5(\cos 2\pi x + \cos 2\pi y)] + e + 20$$

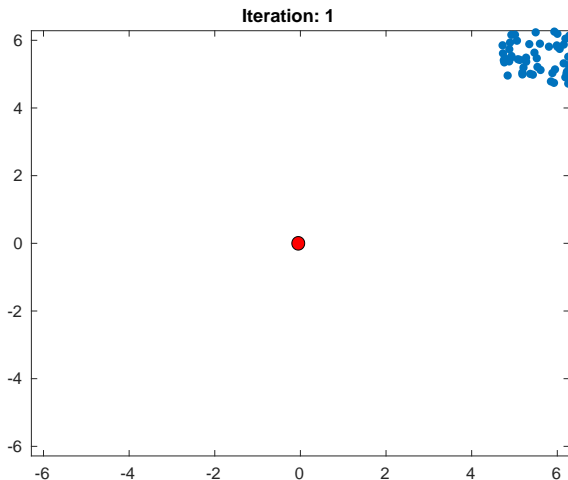

Particle swarm optimization

Ackley function: $f(x, y) =$

$$-20 \exp \left[-0.2 \sqrt{0.5(x^2 + y^2)} \right] - \exp [0.5(\cos 2\pi x + \cos 2\pi y)] + e + 20$$

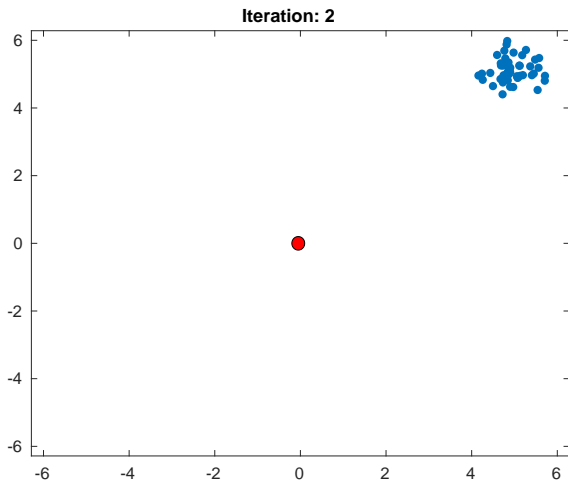

Particle swarm optimization

Ackley function: $f(x, y) =$

$$-20 \exp \left[-0.2 \sqrt{0.5(x^2 + y^2)} \right] - \exp [0.5(\cos 2\pi x + \cos 2\pi y)] + e + 20$$

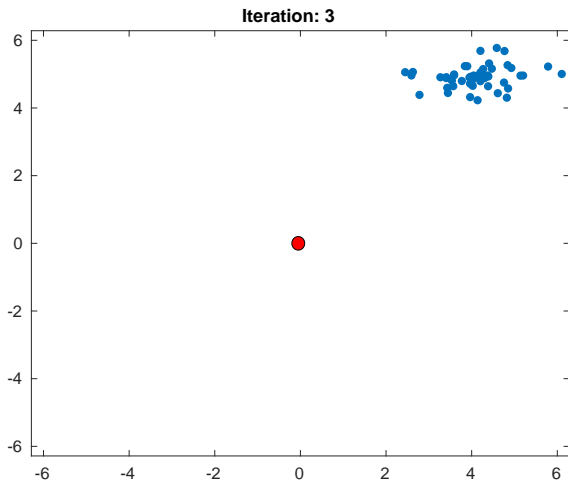

Particle swarm optimization

Ackley function: $f(x, y) =$

$$-20 \exp \left[-0.2 \sqrt{0.5(x^2 + y^2)} \right] - \exp [0.5(\cos 2\pi x + \cos 2\pi y)] + e + 20$$

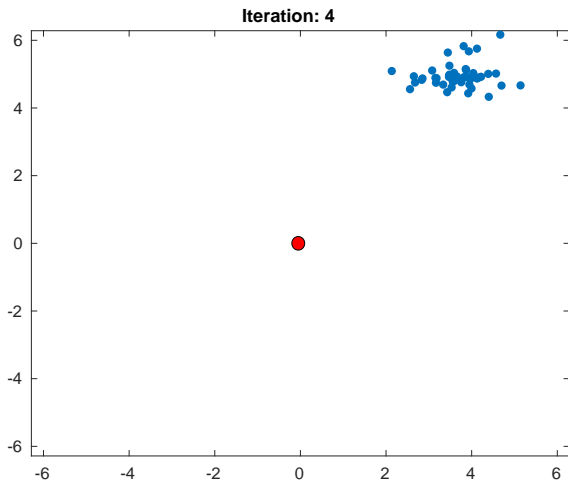

Particle swarm optimization

Ackley function: $f(x, y) =$

$$-20 \exp \left[-0.2 \sqrt{0.5(x^2 + y^2)} \right] - \exp [0.5(\cos 2\pi x + \cos 2\pi y)] + e + 20$$

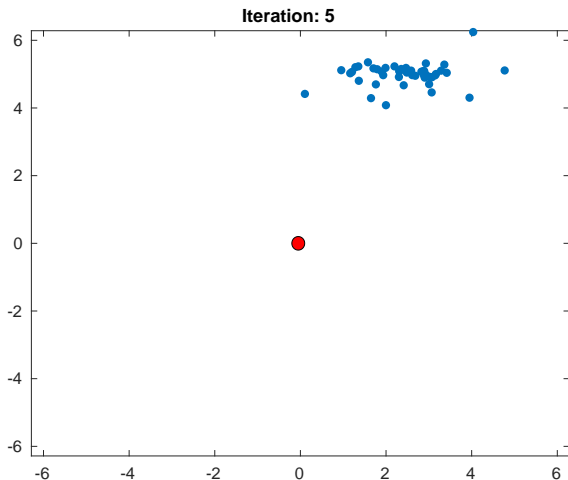

Particle swarm optimization

Ackley function: $f(x, y) =$

$$-20 \exp \left[-0.2 \sqrt{0.5(x^2 + y^2)} \right] - \exp [0.5(\cos 2\pi x + \cos 2\pi y)] + e + 20$$

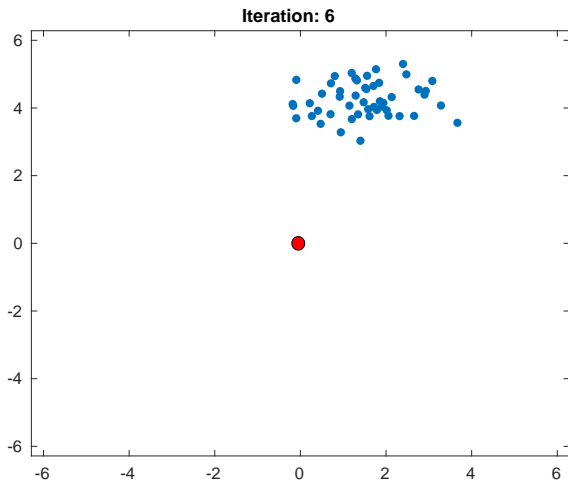

Particle swarm optimization

Ackley function: $f(x, y) =$

$$-20 \exp \left[-0.2 \sqrt{0.5(x^2 + y^2)} \right] - \exp [0.5(\cos 2\pi x + \cos 2\pi y)] + e + 20$$

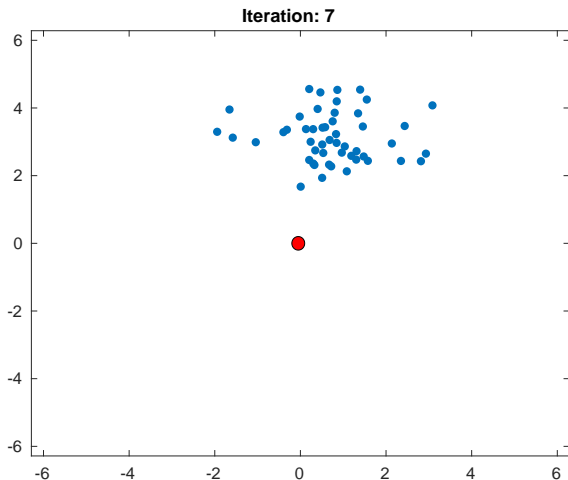

Particle swarm optimization

Ackley function: $f(x, y) =$

$$-20 \exp \left[-0.2 \sqrt{0.5(x^2 + y^2)} \right] - \exp [0.5(\cos 2\pi x + \cos 2\pi y)] + e + 20$$

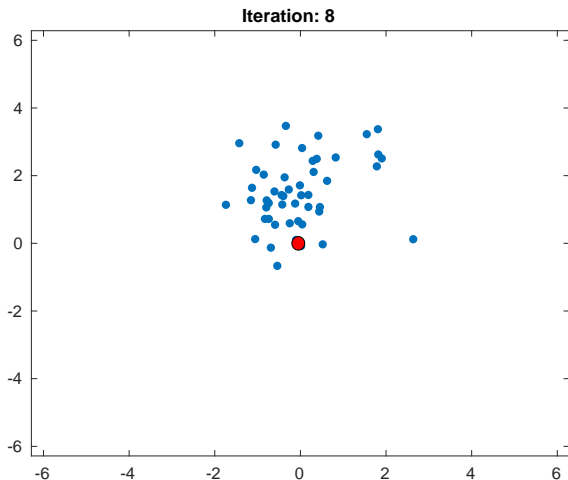

Particle swarm optimization

Ackley function: $f(x, y) =$

$$-20 \exp \left[-0.2 \sqrt{0.5(x^2 + y^2)} \right] - \exp [0.5(\cos 2\pi x + \cos 2\pi y)] + e + 20$$

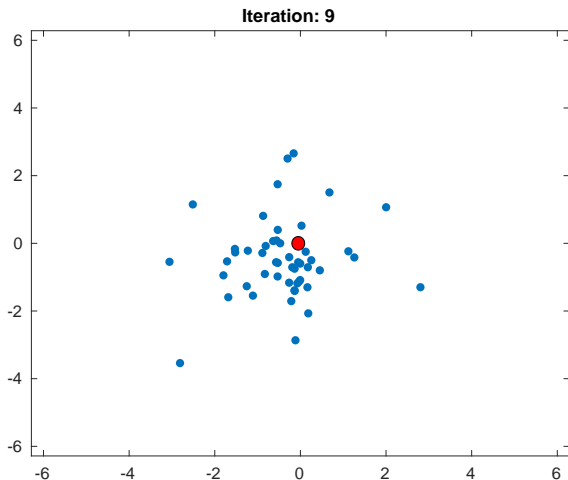

Particle swarm optimization

Ackley function: $f(x, y) =$

$$-20 \exp \left[-0.2 \sqrt{0.5(x^2 + y^2)} \right] - \exp [0.5(\cos 2\pi x + \cos 2\pi y)] + e + 20$$

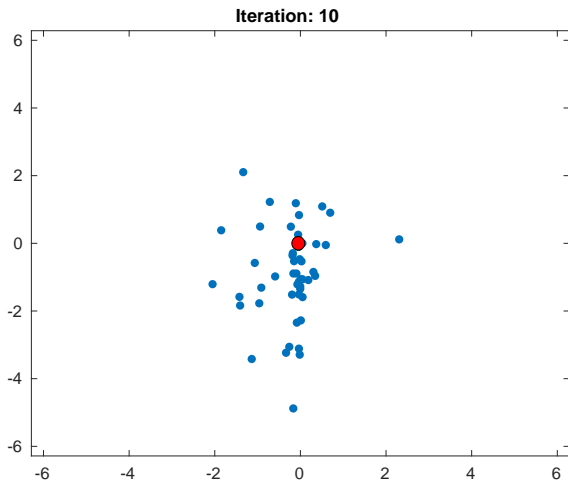

Particle swarm optimization

Ackley function: $f(x, y) =$

$$-20 \exp \left[-0.2 \sqrt{0.5(x^2 + y^2)} \right] - \exp [0.5(\cos 2\pi x + \cos 2\pi y)] + e + 20$$

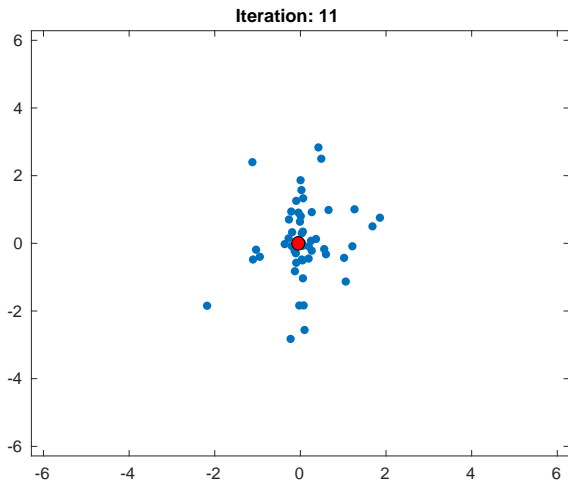

Particle swarm optimization

Ackley function: $f(x, y) =$

$$-20 \exp \left[-0.2 \sqrt{0.5(x^2 + y^2)} \right] - \exp [0.5(\cos 2\pi x + \cos 2\pi y)] + e + 20$$

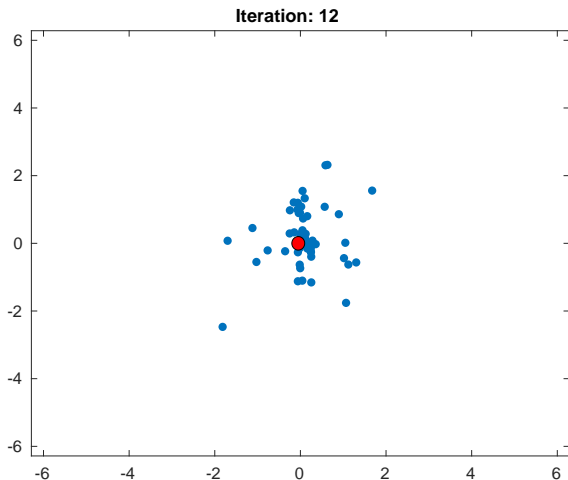

Particle swarm optimization

Ackley function: $f(x, y) =$

$$-20 \exp \left[-0.2 \sqrt{0.5(x^2 + y^2)} \right] - \exp [0.5(\cos 2\pi x + \cos 2\pi y)] + e + 20$$

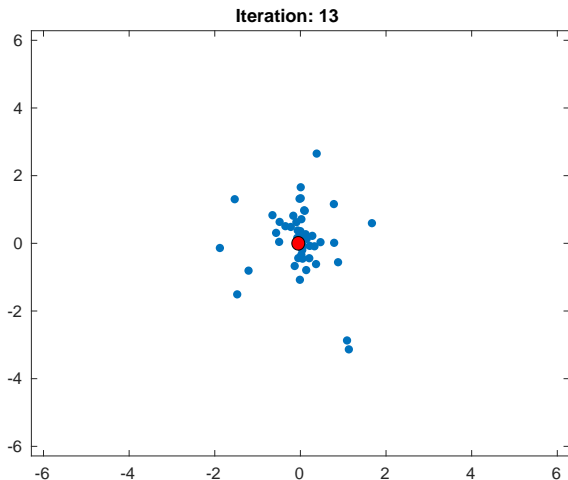

Particle swarm optimization

Ackley function: $f(x, y) =$

$$-20 \exp \left[-0.2 \sqrt{0.5(x^2 + y^2)} \right] - \exp [0.5(\cos 2\pi x + \cos 2\pi y)] + e + 20$$

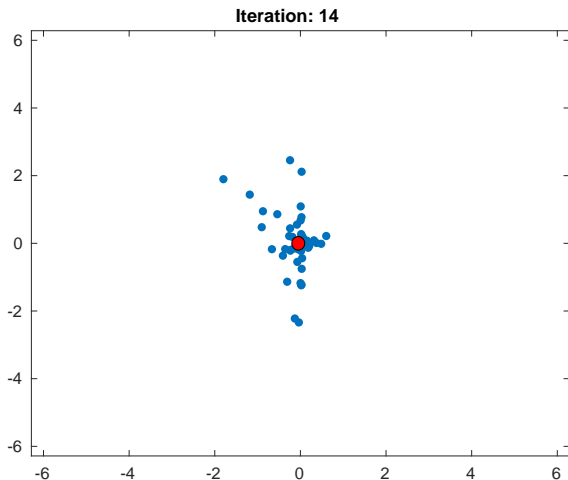

Particle swarm optimization

Ackley function: $f(x, y) =$

$$-20 \exp \left[-0.2 \sqrt{0.5(x^2 + y^2)} \right] - \exp [0.5(\cos 2\pi x + \cos 2\pi y)] + e + 20$$

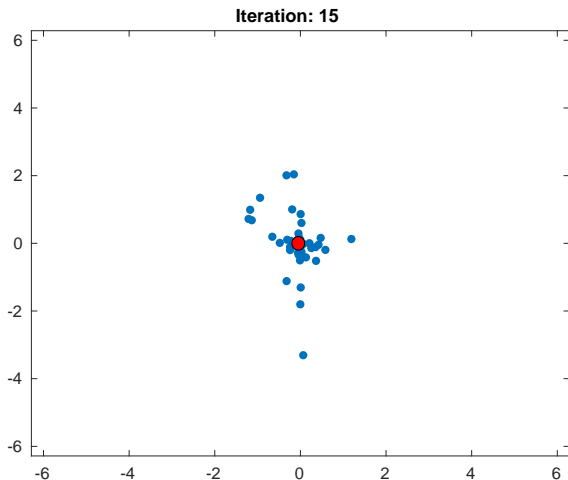

Particle swarm optimization

Ackley function: $f(x, y) =$

$$-20 \exp \left[-0.2 \sqrt{0.5(x^2 + y^2)} \right] - \exp [0.5(\cos 2\pi x + \cos 2\pi y)] + e + 20$$

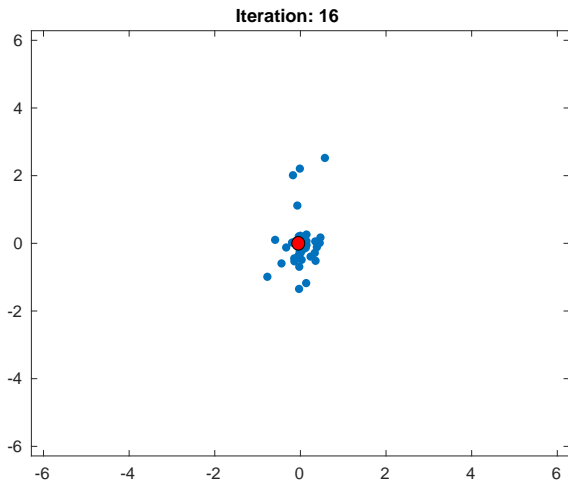

Particle swarm optimization

Ackley function: $f(x, y) =$

$$-20 \exp \left[-0.2 \sqrt{0.5(x^2 + y^2)} \right] - \exp [0.5(\cos 2\pi x + \cos 2\pi y)] + e + 20$$

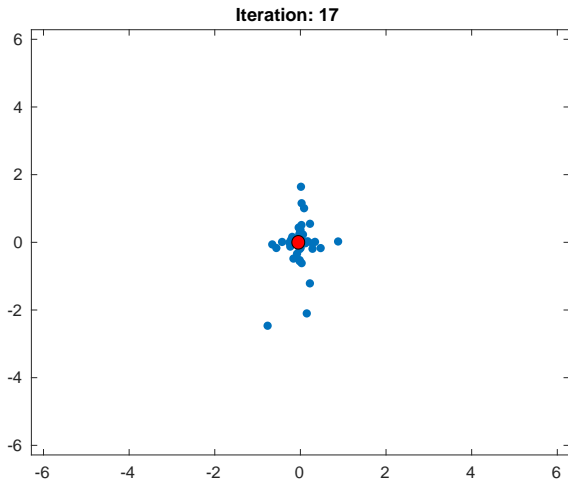

Particle swarm optimization

Ackley function: $f(x, y) =$

$$-20 \exp \left[-0.2 \sqrt{0.5(x^2 + y^2)} \right] - \exp [0.5(\cos 2\pi x + \cos 2\pi y)] + e + 20$$

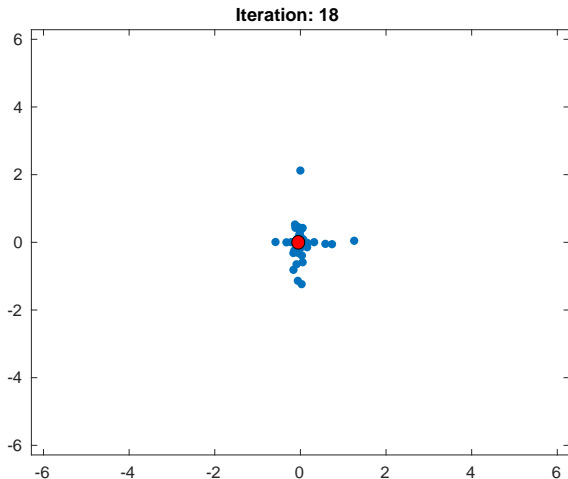

Particle swarm optimization

Ackley function: $f(x, y) =$

$$-20 \exp \left[-0.2 \sqrt{0.5(x^2 + y^2)} \right] - \exp [0.5(\cos 2\pi x + \cos 2\pi y)] + e + 20$$

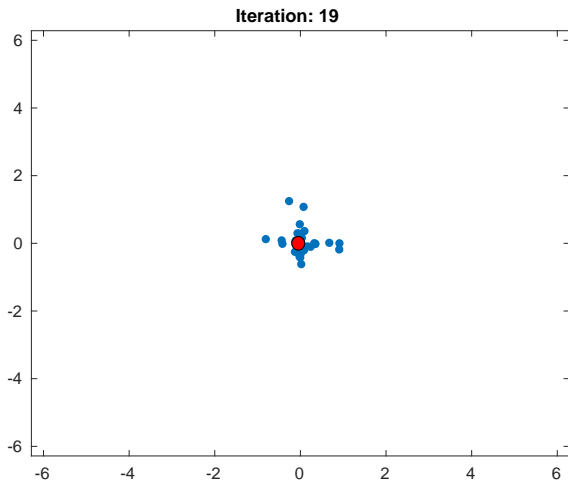

Particle swarm optimization

Ackley function: $f(x, y) =$

$$-20 \exp \left[-0.2 \sqrt{0.5(x^2 + y^2)} \right] - \exp [0.5(\cos 2\pi x + \cos 2\pi y)] + e + 20$$

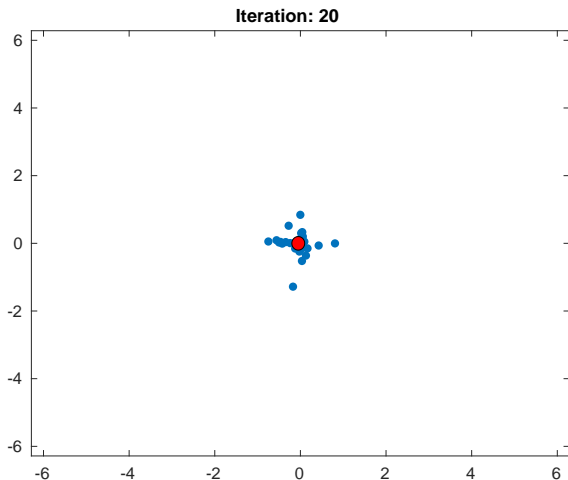

Particle swarm optimization

Ackley function: $f(x, y) =$

$$-20 \exp \left[-0.2 \sqrt{0.5(x^2 + y^2)} \right] - \exp [0.5(\cos 2\pi x + \cos 2\pi y)] + e + 20$$

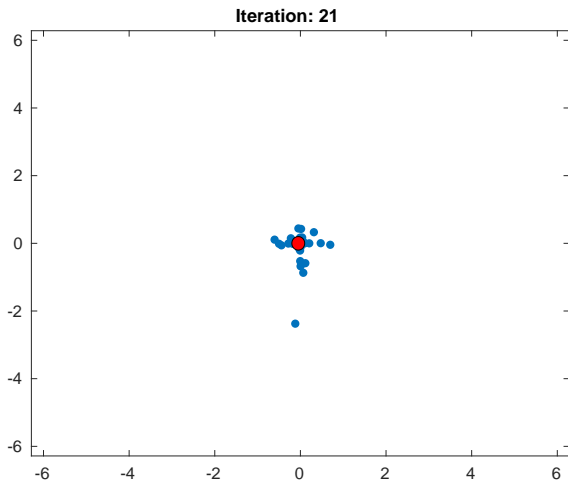

Particle swarm optimization

Ackley function: $f(x, y) =$

$$-20 \exp \left[-0.2 \sqrt{0.5(x^2 + y^2)} \right] - \exp [0.5(\cos 2\pi x + \cos 2\pi y)] + e + 20$$

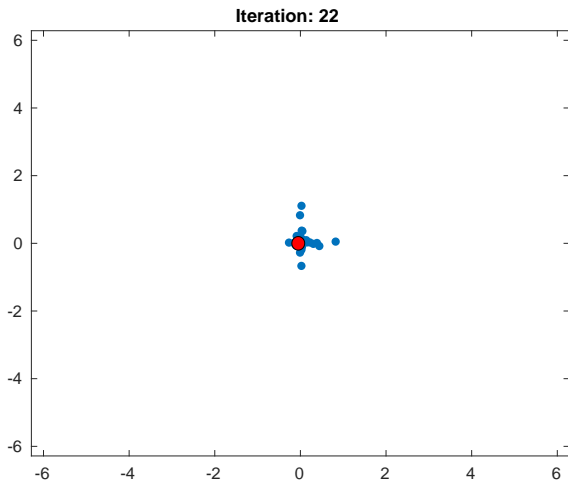

Particle swarm optimization

Ackley function: $f(x, y) =$

$$-20 \exp \left[-0.2 \sqrt{0.5(x^2 + y^2)} \right] - \exp [0.5(\cos 2\pi x + \cos 2\pi y)] + e + 20$$

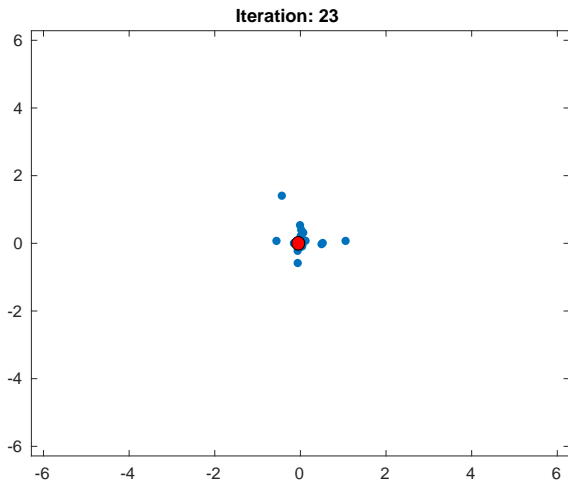

Particle swarm optimization

Ackley function: $f(x, y) =$

$$-20 \exp \left[-0.2 \sqrt{0.5(x^2 + y^2)} \right] - \exp [0.5(\cos 2\pi x + \cos 2\pi y)] + e + 20$$

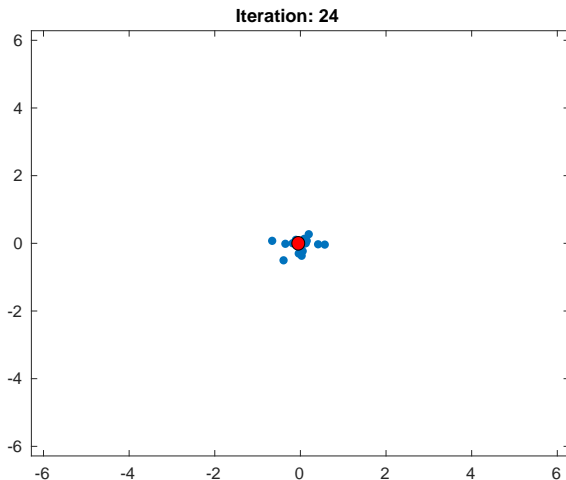

Particle swarm optimization

Ackley function: $f(x, y) =$

$$-20 \exp \left[-0.2 \sqrt{0.5(x^2 + y^2)} \right] - \exp [0.5(\cos 2\pi x + \cos 2\pi y)] + e + 20$$

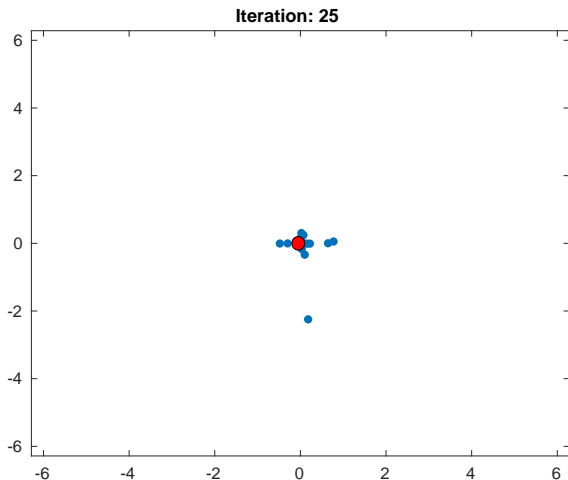

Particle swarm optimization

Ackley function: $f(x, y) =$

$$-20 \exp \left[-0.2 \sqrt{0.5(x^2 + y^2)} \right] - \exp [0.5(\cos 2\pi x + \cos 2\pi y)] + e + 20$$

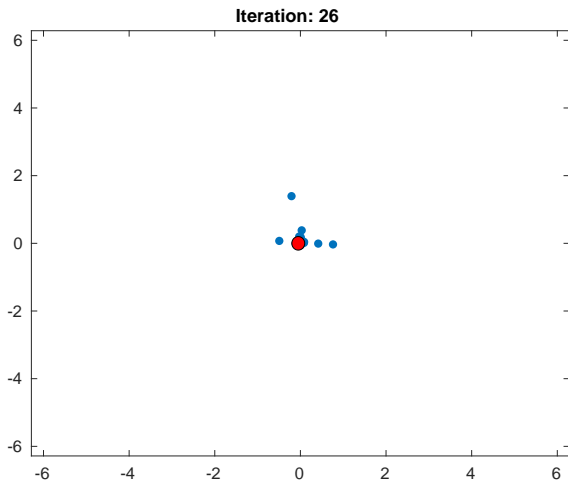

Particle swarm optimization

Ackley function: $f(x, y) =$

$$-20 \exp \left[-0.2 \sqrt{0.5(x^2 + y^2)} \right] - \exp [0.5(\cos 2\pi x + \cos 2\pi y)] + e + 20$$

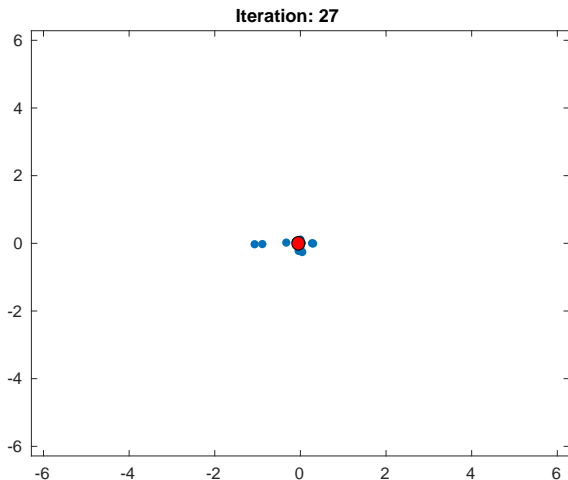

Particle swarm optimization

Ackley function: $f(x, y) =$

$$-20 \exp \left[-0.2 \sqrt{0.5(x^2 + y^2)} \right] - \exp [0.5(\cos 2\pi x + \cos 2\pi y)] + e + 20$$

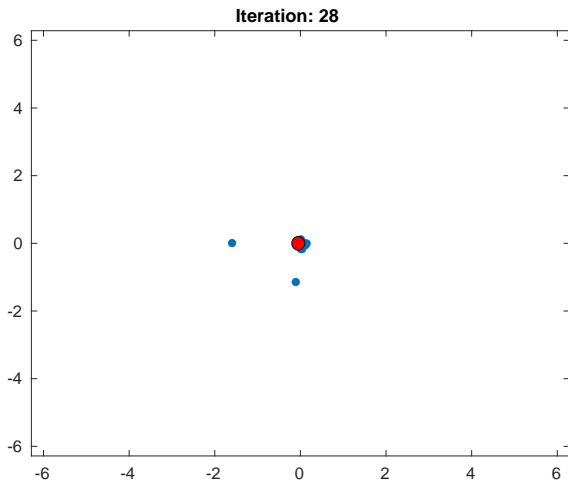

Particle swarm optimization

Ackley function: $f(x, y) =$

$$-20 \exp \left[-0.2 \sqrt{0.5(x^2 + y^2)} \right] - \exp [0.5(\cos 2\pi x + \cos 2\pi y)] + e + 20$$

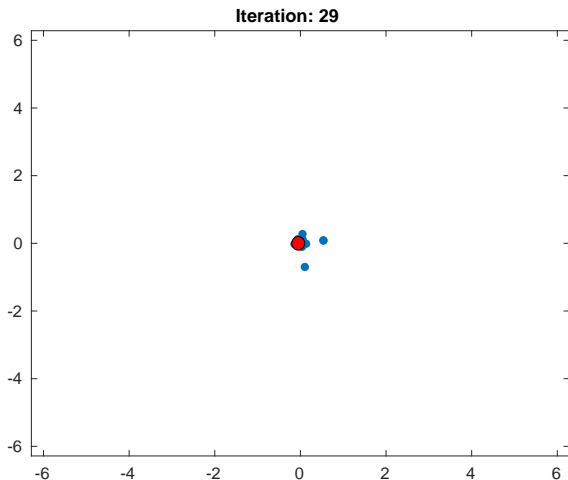

Particle swarm optimization

Ackley function: $f(x, y) =$

$$-20 \exp \left[-0.2 \sqrt{0.5(x^2 + y^2)} \right] - \exp [0.5(\cos 2\pi x + \cos 2\pi y)] + e + 20$$

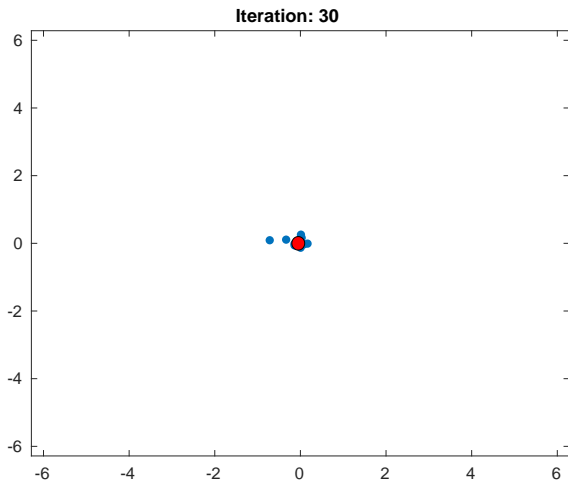

Private capacity of a quantum channel

- ▶ **Private capacity** $P(\mathcal{N})$: highest rate of **private classical communication** between Alice and Bob

- ▶ Coding theorem: [Devetak 2005; Cai et al. 2004]

$$P(\mathcal{N}) = \lim_{n \rightarrow \infty} \frac{1}{n} P^{(1)}(\mathcal{N}^{\otimes n})$$

with the **private information**

$$P^{(1)}(\mathcal{N}) = \max_{\{\rho_i, \rho_i\}} [I(X; B)_\rho - I(X; E)_\rho].$$

- ▶ Private information can be superadditive, [Smith et al. 2008]

$$P^{(1)}(\mathcal{N}^{\otimes n}) > nP^{(1)}(\mathcal{N}).$$

Private capacity of a quantum channel

- ▶ Quantum information transmission is necessarily private:

$$P(\mathcal{N}) \geq Q(\mathcal{N}).$$

- ▶ Also holds for information quantities: $P^{(1)}(\mathcal{N}) \geq Q^{(1)}(\mathcal{N})$.

- ▶ For degradable channels: [Smith 2008]

$$P(\mathcal{N}) = Q(\mathcal{N}) = Q^{(1)}(\mathcal{N}) = P^{(1)}(\mathcal{N}).$$

- ▶ For antidegradable channels: $P(\mathcal{N}) = 0 = Q(\mathcal{N})$.

- ▶ There are channels with $Q(\mathcal{N}) = 0$ and $P(\mathcal{N}) > 0$
(e.g. entanglement-binding channels).

- ▶ Leads to superactivation of $Q(\cdot)$: $\exists \mathcal{N}_1, \mathcal{N}_2$ with $Q(\mathcal{N}_i) = 0$ but $Q(\mathcal{N}_1 \otimes \mathcal{N}_2) > 0$. [Smith and Yard 2008]

Separation of private and coherent information

- Numerical investigations suggest the following is an **optimal**

private ensemble:

$$(|\pm\rangle \sim |0\rangle \pm |1\rangle)$$

$$\rho_1 = \frac{1}{2}, \quad \rho_1 = \lambda|+\rangle\langle+| + (1-\lambda)|-\rangle\langle-|$$

$$\rho_2 = \frac{1}{2}, \quad \rho_2 = \lambda|-\rangle\langle-| + (1-\lambda)|+\rangle\langle+|$$

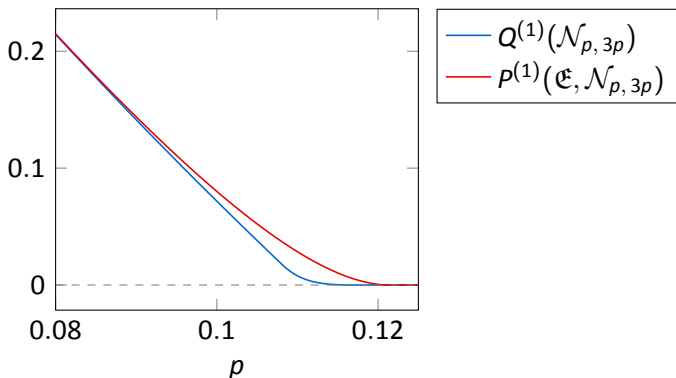

Separation of private and coherent information

- ▶ Separation of capacities? $P(\mathcal{N}_{p,q}) > Q(\mathcal{N}_{p,q}) (= 0)$?
- ▶ superadditivity of private information?
 $P^{(1)}(\mathcal{N}_{p,q}^{\otimes n}) > nP^{(1)}(\mathcal{N}_{p,q})$?

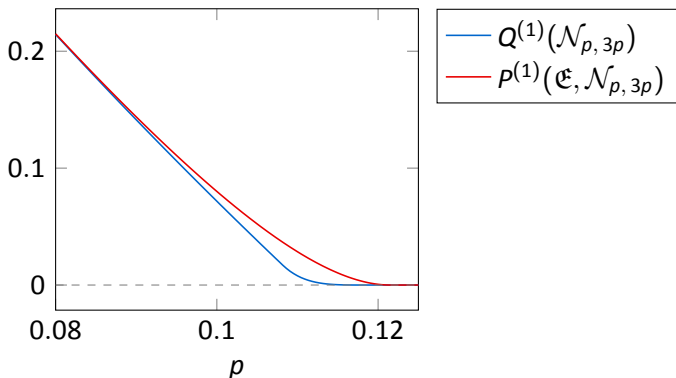

Table of Contents

- 1 Quantum capacity of a quantum channel
- 2 (Anti)degradable channels and quantum capacity bounds
- 3 Dephasure channel and its properties
- 4 Summary & Outlook**

Summary

- ▶ Discussed an upper bound on quantum capacity of a channel based on **decomposition into degradable and antidegradable channels**.
- ▶ Question of optimality leads to the **dephasure channel**

$$\mathcal{N}_{p,q}(\rho) = (1 - q)((1 - p)\rho + pZ\rho Z) + q \text{Tr}(\rho)|e\rangle\langle e|.$$

- ▶ Dephasure channel checks a lot of marks on "weirdness chart":
 - ▷ superadditivity of coherent information for two uses
 - ▷ separation of private and coherent information
 - ▷ possible superadditivity of private information?

Outlook

- ▶ Some open questions:
 - ▷ Formula for single-letter private information (needed to show superadditivity)?
 - ▷ Tight upper bounds on quantum capacity?
 - ▷ Increase threshold up to region of antidegradability?
- ▶ Further effects of superadditivity? → superadditivity in classical communication with limited entanglement assistance (ongoing work with Elton Zhu, Quntao Zhuang)
- ▶ Can we understand the superadditivity of coherent information in the light of the recent work on α -bit capacities?

References

- Bausch, J. and F. Leditzky (2018). *arXiv preprint*. arXiv: 1806.08781 [quant-ph].
- Cai, N. et al. (2004). *Problems of Information Transmission* 40.4, pp. 318–336.
- Devetak, I. (2005). *IEEE TIT* 51.1, pp. 44–55. arXiv: quant-ph/0304127.
- Devetak, I. and P. W. Shor (2005). *CMP* 256.2, pp. 287–303. arXiv: quant-ph/0311131 [quant-ph].
- DiVincenzo, D. P. et al. (1998). *Physical Review A* 57.2, p. 830. arXiv: quant-ph/9706061.
- Dieks, D. (1988). *Physics Letters A* 126.5, pp. 303–306.
- Ivanovic, I. (1987). *Physics Letters A* 123.6, pp. 257–259.
- Leditzky, F. et al. (2018a). *IEEE TIT* 64.7, pp. 4689–4708. arXiv: 1701.03081 [quant-ph].
- Leditzky, F. et al. (2018b). *Physical Review Letters* 120.16, p. 160503. arXiv: 1705.04335 [quant-ph].
- Leung, D. and W. Matthews (2015). *IEEE TIT* 61.8, pp. 4486–4499. arXiv: 1406.7142 [quant-ph].
- Lloyd, S. (1997). *Physical Review A* 55.3, p. 1613. arXiv: quant-ph/9604015.
- Peres, A. (1988). *Physics Letters A* 128.1, p. 19.
- Shor, P. W. (2002). *MSRI Workshop on Quantum Computation*. Berkeley, CA, USA.
- Smith, G. (2008). *Physical Review A* 78.2, p. 022306. arXiv: 0705.3838 [quant-ph].
- Smith, G. and J. A. Smolin (2008). *2008 IEEE ITW*. IEEE, pp. 368–372. arXiv: 0712.2471 [quant-ph].
- Smith, G. and J. Yard (2008). *Science* 321.5897, pp. 1812–1815. arXiv: 0807.4935 [quant-ph].
- Smith, G. et al. (2008). *Physical Review Letters* 100.17, p. 170502. arXiv: quant-ph/0607018.
- Sutter, D. et al. (2017). *IEEE TIT* 63.12, pp. 7832–7844. arXiv: 1412.0980 [quant-ph].
- Wang, X. et al. (2017). *arXiv preprint*. arXiv: 1709.00200 [quant-ph].
- Wolf, M. M. and D. Pérez-García (2007). *Physical Review A* 75.1, p. 012303. arXiv: quant-ph/0607070.
- Yang, D. Manuscript in preparation.

Thank you very much for your attention!

Announcement: QIP 2019

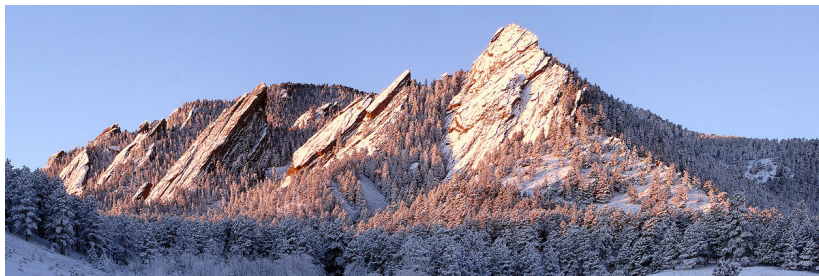

QIP 2019: Jan 14-18, 2019 at  University of Colorado
Boulder

Website: jila.colorado.edu/qip2019

Local organizers: Felix Leditzky, Graeme Smith

Program committee chair: Matthias Christandl

Submission deadline: sometime in September (TBD)